

Gerber P2C™ 1600 User's Manual



IMPORTANT

Before you begin...

Please complete the attached Warranty Registration Card and return it to Gerber today, or go through the online registration at <http://www.gspinc/products/registration/index.html>.

Failure to register may result in delayed responses to your warranty and service inquiries.

FCC NOTICE

Warning: Changes or modifications to this unit not expressly approved by the party responsible for compliance could void the user's authority to operate the equipment.

Note: This equipment has been tested and found to comply with the limits for a Class A digital device, pursuant to Part 15 of the FCC rules. These limits are designed to provide reasonable protection against harmful interference when the equipment is operated in a commercial environment. This equipment generates, uses, and can radiate radio frequency energy and, if not installed and used in accordance with the instruction manual, may cause harmful interference to radio communications. Operation of this equipment in a residential area is likely to cause harmful interference in which case the user will be required to correct the interference at his own expense.

RS-232 shielded cables must be used with this unit to ensure compliance with the Class A FCC limits.

This Class A digital apparatus complies with Canadian ICES-003.
Cet appareil numérique de la classe A est conforme à la norme NMB-003 du Canada.

NOTICE

Gerber reserves the right to modify the information contained in this User Manual at any time without prior notice. Unauthorized copying, modification, distribution or display is prohibited. All rights reserved. All queries, comments or suggestions concerning this and other Gerber manuals should be directed to:

Gerber Scientific Products
83 Gerber Road
South Windsor, CT 06074 USA
860-643-1515

Customer Service: 800-222-7446
Technical Support: 800-828-5406 / 860-644-6971
Fax 800-227-6228 / 860-871-3862

www.gspinc.com

© Copyright 2005, Gerber Scientific International, Inc.

TRADEMARK ACKNOWLEDGEMENTS

GERBER EDGE, EDGE and Gerber Scientific Products are registered trademarks and Gerber P2C and FastFacts are trademarks of Gerber Scientific Products.

3M, Scotchcal, Scotchlite, Controltac, Comply and Panaflex are trademarks of the 3M Corporation.

DM/PL and Houston Instrument are trademarks of Summagraphics Corporation.

HP-GL is a trademark of Hewlett-Packard Company.

IBM PC, IBM PC/XT, and IBM AT are trademarks of International Business Machines Corp.

Macintosh, Macintosh Plus, Macintosh SE, and Macintosh II are trademarks of Apple Computer.

TABLE OF CONTENTS	Page
SECTION 1	1-1
1 GENERAL INFORMATION	1-1
1.1 INTRODUCTION	1-1
1.1.1 PRODUCT FEATURES	1-2
1.1.2 GERBER P2C 1600 USER MANUAL	1-3
1.2 SPECIFICATIONS	1-4
1.2.1 CUTTER	1-4
1.2.2 MEDIA	1-4
1.2.3 KNIFE, PEN AND POUNCING TOOL	1-6
1.2.4 INTERFACE	1-6
1.2.5 FIRMWARE	1-7
1.2.6 PERFORMANCE	1-7
1.2.7 CERTIFICATIONS.....	1-7
1.2.8 ENVIRONMENTAL	1-8
1.2.9 ELECTRICAL.....	1-8
1.3 CUTTER ACCESSORIES AND CONSUMABLES	1-9
1.4 REAR PANEL COMPONENTS	1-10
1.5 FRONT PANEL CONTROLS	1-12
1.6 POWERING UP THE CUTTER	1-14
1.6.1 EARTHING	1-14
1.7 INSTALLATION OF A KNIFE, PEN OR POUNCING TOOL	1-16
1.7.1 KNIFE INSTALLATION	1-16
1.7.2 PEN INSTALLATION.....	1-19
1.7.3 INSTALLATION OF THE POUNCING TOOL	1-20
1.8 LOADING MEDIA	1-21
1.8.1 POSITIONING THE PINCH ROLLERS	1-21
1.8.2 FEEDING AND POSITIONING MEDIA	1-22
1.9 MEDIA LOAD PROCEDURE	1-26

SECTION 2	1-1
2 OPERATION	2-1
2.1 THE CONTROL PANEL	2-1
2.1.1 THE LIQUID CRYSTAL DISPLAY	2-2
2.1.2 THE RESET/LOAD KEY	2-2
2.1.3 THE ONLINE KEY	2-3
2.1.4 THE MENU KEY	2-3
2.1.5 THE ENTER KEY	2-5
2.1.6 THE 1 AND 2 KEYS 1 - 2.....	2-5
2.1.7 THE JOGGING KEYS	2-5
2.1.8 THE TOOL UP/DOWN KEY	2-5
2.1.9 THE TOOL SELECT KEY	2-5
2.2 NORMAL OPERATION	2-6
2.2.1 ONLINE AND OFFLINE	2-6
2.2.2 LOCAL OPERATION	2-7
2.3 THE USER CONFIG MENU	2-8
2.3.1 KNIFE PRESSURE	2-10
2.3.2 KNIFE OFFSET.....	2-10
2.3.3 POUNCING PRESSURE	2-10
2.3.4 VELOCITY	2-10
2.3.5 OVERCUT	2-11
2.3.6 POUNCING GAP	2-11
2.3.7 SYSTEM SETUP.....	2-11
2.4 SYSTEM SET UP	2-12
2.4.1 CONCATENATION	2-12
2.4.2 SMOOTHING.....	2-12
2.4.3 EMULATE	2-12
2.4.4 TOOL	2-13
2.4.5 MENU UNITS	2-13
2.4.6 ADDRESSING	2-13
2.4.7 BAUD RATE.....	2-13
2.4.8 PARITY	2-14
2.4.9 RTS/DTR	2-14
2.4.10 DM/PL ERRORS.....	2-15
2.4.11 HP-GL ERRORS.....	2-15
2.4.12 HP-GL ORIGIN	2-15
2.4.13 MEDIA SENSOR.....	2-16
2.4.14 AUTOLOAD	2-16
2.4.15 TOOL COMMAND.....	2-16
2.4.16 LOAD ON W CMD.....	2-16
2.4.17 FLEX-CUT	2-17
2.4.18 RECUT OFFSET	2-17

2.5	INTERNAL TEST MENU	2-18
2.5.1	CUT BORDER	2-19
2.5.2	MENU PLOT	2-19
2.5.3	CONFIDENCE CUT	2-19
2.5.4	DIN CUT	2-19
2.5.5	CAL. MEDIA	2-20
2.5.6	CALIBRATION OPOS	2-20
2.5.7	OPOS SETTINGS	2-20
2.5.8	SYSTEM TESTS	2-20
2.6	SYSTEM TESTS	2-21
2.6.1	LANGUAGE	2-21
2.6.2	ROM REVISION	2-21
2.6.3	SERVICE PLOT	2-21
2.6.4	OPTICAL SENSOR	2-22
2.6.5	SENSOR SETUP	2-22
2.6.6	CALIBRATION	2-22
2.6.7	RS232 TEST	2-22
2.6.8	RAM TEST	2-23
2.6.9	INSTALL MENU	2-23
2.6.10	COIL SETUP	2-23
2.6.11	LCD CONTRAST	2-23

3	GENERAL INFORMATION	3-1
3.1	MAINTENANCE & CLEANING.....	3-1
3.1.1	CLEANING THE DRIVE SYSTEM	3-1
3.1.2	CLEANING THE SENSORS	3-2
3.2	OPERATING VOLTAGE CONVERSION	3-3
	SECTION 4.....	3-1
4	INTERFACE	4-1
4.1	INTRODUCTION	4-1
4.2	RS232 INTERFACE NOTES.....	4-1
4.2.1	SYSTEM SETUP.....	4-1
4.2.2	SERIAL INTERFACE CONNECTOR ON THE CUTTER.....	4-2
4.2.3	AVAILABLE SERIAL SIGNALS	4-2
4.3	USB INTERFACE NOTES	4-3
4.3.1	USB SPECIFICATIONS	4-3
4.3.2	INSTALLING THE USB SOFTWARE UNDER WINDOWS.....	4-3
4.3.3	INSTALLING THE USB SOFTWARE FOR YOUR MACINTOSH	4-4
4.3.4	PARALLEL INTERFACE CONNECTOR ON CUTTER	4-5
5	MEDIA CERTIFICATION.....	A-1

LIST OF ILLUSTRATIONS	Page
GERBER P2C 1600, REAR VIEW*	1-10
GERBER P2C 1600, FRONT VIEW	1-12
EARTH CONNECTION.....	1-15
BLADE INSERTION.....	1-16
BLADE LENGTH ADJUSTMENT.....	1-17
SETTING KNIFE DEPTH	1-17
KNIFE DEPTH TEST PATTERN.....	1-18
MEDIA POSITIONING	1-22
FEEDING ROLL MEDIA USING MEDIA FLANGES	1-23
FEEDING ROLL MEDIA WITHOUT USING MEDIA FLANGES.....	1-24
PINCH ROLLER POSITIONING	1-24
GERBER P2C 1600, CONTROL PANEL	2-1
GERBER P2C 1600 CONFIGURATION SUBMENUS.....	2-4
FLOWCHART SHOWING FACTORY PRESET MENU SETTINGS.....	2-9
INTERNAL TESTS SUBMENU	2-18
CLEANING OF THE DRIVE SLEEVES.....	3-2
LOCATION OF THE SENSORS	3-2
POWER ENTRY MODULE	3-3

LIST OF TABLES	Page
GERBER P2C 1600 CUTTER SPECIFICATIONS.....	1-4
GERBER P2C 1600 MEDIA SPECIFICATIONS	1-4
GERBER P2C 1600 KNIVES, PENS AND POUNCING TOOLS	1-6
GERBER P2C 1600 INTERFACE SPECIFICATIONS.....	1-6
GERBER P2C 1600 FIRMWARE.....	1-7
GERBER P2C 1600 PERFORMANCES.....	1-7
GERBER P2C 1600 ENVIRONMENTAL SPECIFICATIONS	1-8
GERBER P2C 1600 ELECTRICAL SPECIFICATIONS.....	1-8
GERBER P2C 1600 ACCESSORIES AND CONSUMABLES.....	1-9

SECTION 1

1 GENERAL INFORMATION

1.1 INTRODUCTION

The Gerber P2C™ Series family of cutters has been designed to produce computer-generated graphic designs on cut sheet or roll vinyl media. By replacing the knife with a fiber tip pen, these cutters can also be used to produce inexpensive previews of new graphic designs on paper.

This manual is a reference guide for installing and operating the Gerber P2C 1600 cutter. This cutter model features a drag knife and can handle media widths from 170 mm up to 1620 mm (4" to 63.8").

1.1.1 PRODUCT FEATURES

The following are the main features of the Gerber P2C 1600 cutter.

- Variable media widths.
- User-selectable DM/PL™, HP-GL™ and HP-GL/2™ software languages.
- Interchangeable pen for producing preview plots of sign designs on paper.
- Adjustable knife pressure and offset settings controlled by microprocessor.
- Communication with host computer via USB rev 1.1, standard serial RS-32-C, or Centronics parallel interface.
- 12-key control panel.
- Metric or English units.
- User-addressable resolution: 0.1 mm, 0.025 mm, 0.001" or 0.005".
- Menu mode for selecting the cutter's power-up operating configuration.
- Convenient 2-line, 16-character liquid crystal display (LCD).
- Extensive internal test routines.
- Wide variety of cutting speeds (in metric or English units).
- Up to four separate user configurations that are stored in non-volatile memory.
- Media support system for automatic loading of media with optional "shuffling" to guarantee tracking of longer signs.
- Automatic media pull from roll.
- Media sensing.
- Simple origin adjustment to any location.
- Concatenation and curve smoothing to obtain better cut quality.
- Multiple recut feature.
- Knife depth and offset tests.
- Overcut for easy weeding.
- OPOS 2.0 functionality.

1.1.2 GERBER P2C 1600 USER MANUAL

This user manual provides the following information:

- Full technical specifications for the Gerber P2C 1600 cutters and compatible media.
- A complete description of the main components of the Gerber P2C 1600 cutters.
- Step-by-step instructions for knife and pen installation and media loading.
- Instructions for online and local mode (🖱️) operations.
- Instructions for USER CONFIGURATION and INTERNAL TESTS operations.
- Maintenance and cleaning instructions.
- Information about the USB, RS-232-C, and Centronics interface cables used to connect the cutter to IBM, IBM-compatible, Apple and Apple-compatible host computers.

1.2 SPECIFICATIONS

1.2.1 CUTTER

		Gerber P2C 1600	
		with standard stand	
		mm	inch
Height	without stand	255	10.04
	with stand	1010	40
Width	without stand	2260	89
	with stand	2260	89
Depth	without stand	550	21.65
	with stand	740	29
Weight	without stand	45.4 kg	95.5 lbs
	with stand	100 kg	220.5 lbs

TABLE 1-1:
GERBER P2C 1600 CUTTER SPECIFICATIONS

1.2.2 MEDIA

	D1600 SL	
	mm	inch
Width	170 to 1620	6.7 to 63.8
Maximum cutting width	1575	62
Min margin left/right (*)	25	1
Front margin	25	1
Rear margin		
Sensor on	42	1.7
Sensor off	30	1.2
Tracking Performance	+/- 0.1mm up to 12 m (vinyl < 760mm) (**) +/- 0.004" up to 39 feet (vinyl < 30") (***)	+/- 0.1mm up to 4 m (vinyl >760mm) (**) +/- 0.004" up to 13 feet (vinyl >30") (***)
Media Thickness	0.05mm to 0.25mm 0.002" to 0.01"	Up to 0.8mm with optional sandblast knife Up to 0.03" with optional sandblast knife

(*) for positioning of the pinch rollers (see section 1.8.)

(**) Media lengths greater than 12 m (39 feet) can be handled, but compliance with specifications is not guaranteed (will be dependent on media type, media size and other parameters).

(***) Media lengths greater than 4 m (13 feet) can be handled, but compliance with specifications is not guaranteed (will be dependent on media type, media size and other parameters).

TABLE 1-2:
GERBER P2C 1600 MEDIA SPECIFICATIONS

Vinyl Types

A wide range of vinyl types has been evaluated and tested on the Gerber P2C 1600 cutters. When using duly certified media, operation in accordance with the functional specifications of the model is warranted. Gerber should certify other media before use to ensure performance in compliance with specifications.

See Appendix A for a full list of all Gerber duly certified media suitable for friction drive operation.

Plotting Paper

Bond paper (120 g/m² recommended)

1.2.3 KNIFE, PEN, AND POUNCING TOOL

The Gerber P2C cutters are supplied with two standard knife blades (for vinyl media) and a black fibre tip pen.

Tool	Medium	Quantity
Standard knife (requires a standard knife holder)	Standard, reflective & fluorescent vinyl	2 off
Sandblast knife	Sandblast & thick material	optional
Pouncing tool	Paper	optional
Pen	Color	Quantity
Fibre tip pen	Black	1 off

TABLE 1-3:
GERBER P2C 1600 KNIVES, PENS, AND POUNCING TOOLS

To order replacement knives, pens, and/or pouncing tools, contact your local dealer, quoting the part numbers listed in table 1-9.

The Gerber P2C cutters will only perform according to specifications if a genuine Gerber knife, pen or pouncing tool is installed. Do not replace the standard knife, pen or pouncing tool with products from other manufacturers.

1.2.4 INTERFACE

Communication	USB ver 1.1, standard asynchronous RS-232-C and Centronics parallel interface
USB : I/O Port connector	USB series "B" receptacle
Mating connector	USB series "B" plug
Serial : I/O Port connector	DB-9P
Mating connector	DB-9S
Byte format	8 data bits, 2 stop bits, no parity
Baud rate	38400, 19200, 9600, 4800, 2400 bps
Parallel: I/O Port connector	Centronics female
Mating connector	Centronics male

TABLE 1-4:
GERBER P2C 1600 INTERFACE SPECIFICATIONS

1.2.5 FIRMWARE

Languages	DM/PL, HP-GL, and HP-GL/2 (with selectable origin HP7475 and HP 7580/7585)
Supported character sets	Standard ASCII
Supported fonts	Sans serif (single stroke & medium)
ROM-based plots	Confidence plot, DIN plot

TABLE 1-5:
GERBER P2C 1600 FIRMWARE

1.2.6 PERFORMANCE

Specifications for cutting on 0.05 mm (0.002") wax-backed vinyl having a total media thickness not greater than 0.25 mm (0.010").

Axial speed	50 to 1000 mm/s	2 to 40 ips
Default speed	800 mm/s	32 ips
Acceleration	3 G	3 G
Addressable resolution	0.025 mm, 0.1 mm	0.001", 0.005"
Default resolution	0.025 mm	0.001"
Mechanical resolution	0.0127 mm	0.0005"
Accuracy	0.2% of move or 0.25 mm, whichever is greater*	0.2% of move or 0.010", whichever is greater*
Knife pressure	0 to 400 gr.	0 to 400 gr.
Pen pressure	0 to 400 gr.	0 to 400 gr.
Pouncing pressure	0 to 400 gr.	0 to 400 gr.

*Excludes differences due to media expansion, stretching, etc.

TABLE 1-6:
GERBER P2C 1600 PERFORMANCE

1.2.7 CERTIFICATIONS

CE Certificate
FCC Class A
Complies with UL 1950, CSA 950

1.2.8 ENVIRONMENTAL (CUTTER WITHOUT MEDIA)

Operating Temperature	15 to 35° C	59 to 95° F
Storage temperature	-30 to 70° C	-22 to 158° F
Relative humidity	35 - 85%, non con- densing	35 - 85%, non con- densing

TABLE 1-7:
GERBER P2C 1600 ENVIRONMENTAL SPECIFICATIONS



IMPORTANT HINT

The use of dimensionally stable media is an essential prerequisite to obtaining high cut quality. Additionally, media expansion or contraction may occur as a result of temperature variations. To improve the dimensional stability of media, allow it to acclimate to the current environmental conditions for at least 24 hours prior to use.

1.2.9 ELECTRICAL

Main Supply: 48-62 Hz, single phase.

Nominal line	Min./Max. line	Fuse
100 V AC	89 - 108 V AC	1.25 A, Slo-Blo
120 V AC	108 - 130 V AC	1.25 A, Slo-Blo
220 V AC	197 - 238 V AC	0.6 A, Slo-Blo
240 V AC	216 - 260 V AC	0.6 A, Slo-Blo

TABLE 1-8:
GERBER P2C 1600 ELECTRICAL SPECIFICATIONS

1.3 CUTTER ACCESSORIES AND CONSUMABLES

The following is an overview of the accessories and consumables available for the various Gerber P2C 1600 models:

OPTIONS/ACCESSORIES/CONSUMABLES
Cutter Stand
User's Manual
Power Supply Cables
Serial Interface Kit, consisting of: - 9 pin to 9 pin cable - 9 pin to 8 pin DIN Converter
USB Cable
Standard knife
Standard knife holder
Sandblast knife
Sandblast knife holder
Flanges for roll media
Manual cut-off razor blades (set of 10)
Razor blade & holder
Pouncing tool

TABLE 1-9:
GERBER P2C 1600 ACCESSORIES AND CONSUMABLES

1.4 REAR PANEL COMPONENTS

In order to get acquainted with your Gerber P2C 1600 cutter, read the following descriptions of the rear panel components. Figure 1-1 shows the location of the main components.

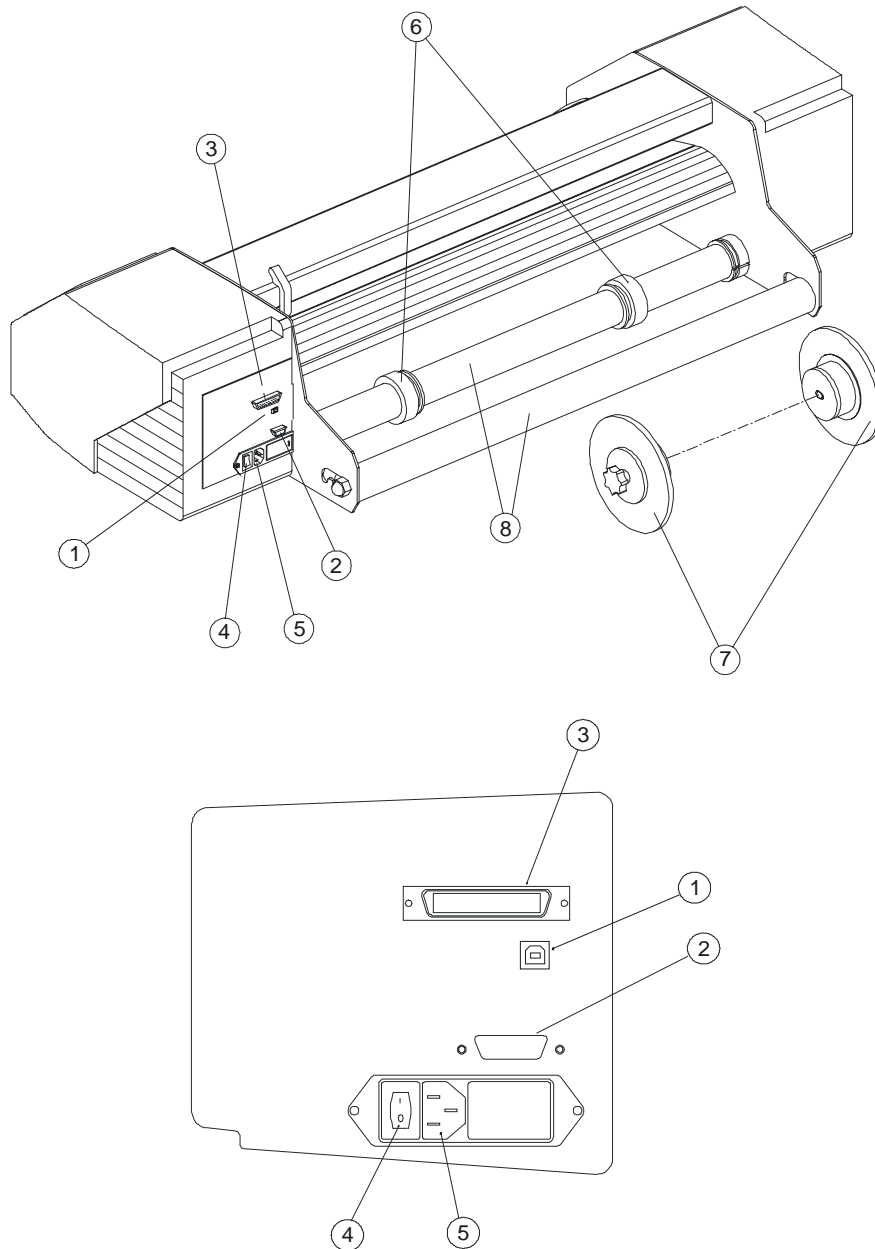

FIGURE 1-1:
GERBER P2C 1600, REAR VIEW*

FOR PRACTICAL REASONS, ILLUSTRATIONS RELATE TO A SMALLER CUTTER MODEL. THE P2C 1600 CUTTERS DIFFER ONLY IN WIDTH AND NUMBER OF PINCH ROLLERS.

-
1. *USB Port:* - This interface is based on the standards specified in Universal Serial Bus Specifications Revision 1.1. It provides high-speed serial bi-directional communication between the host computer and the cutter.
 2. *RS-232-C Port:* - This DB-9P connector provides bidirectional communication between the host computer and the cutter.
 3. *Parallel Port:* - This 36-pin Centronics connector provides unidirectional communication between the host computer and the cutter. The cutter can receive but not transmit data via this port.

Note: Only one of the above three interfaces can be active at any one time.

The first port that receives data will be the active interface until the cutter is reset.

4. *Power ON/OFF switch:* - This rocker switch turns the cutter on and off. To switch the power ON, press the "I" side of the rocker switch. To switch the power OFF, press the "O" side of the rocker switch.
5. *Power Entry Module:* - The fuse box, the voltage select board, and the AC power cord receptacle are located in the power entry module. The power-up procedure is explained in detail in Section 1.6. For information about the conversion of the cutter's operating voltage, see Section 3.2.
6. *Roll Media Guides:* - The two guides keep the roll in place laterally as the media is pulled free. The guides also keep the media flanges in place laterally when the flanges are being used to hold the roll.
7. *Media Flanges:* - The media flanges ensure proper routing of the media roll.
8. *Media Support Rollers:* - Rotating rollers that support the media roll.

1.5 FRONT PANEL CONTROLS

In order to get acquainted with your Gerber P2C 1600 cutter, read the following descriptions of the front panel controls and components.

Figure 1-2 shows the location of the main components.

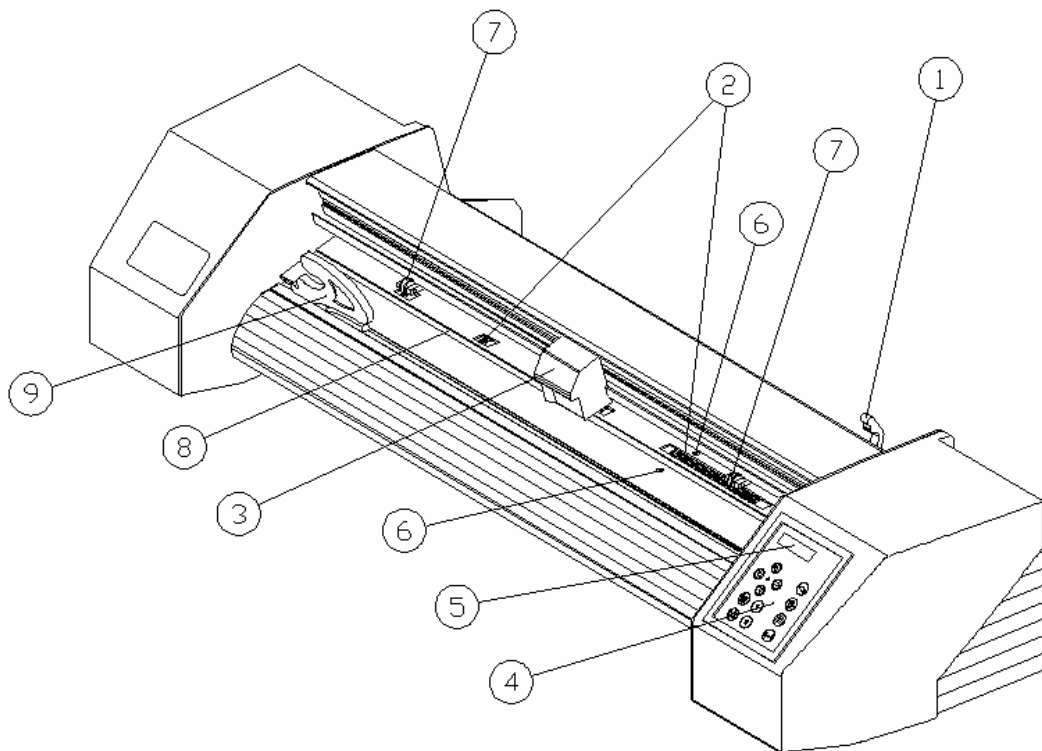



FIGURE 1-2:
GERBER P2C 1600, FRONT VIEW

1. *Pinch roller lever:* - This lever is used to raise and lower the pinch rollers during media loading (media loading is discussed in Section 1.8).
2. *Media Drive Sleeves:* - The media drive sleeves move the media only when the pinch rollers are in the "down" position. The following table lists the number of media drive sleeves installed on the Gerber P2C cutter.

Number of sleeves	D1600 SL
Short sleeve	9
Long sleeve	1

3. *Tool Carriage:* - The tool carriage holds the knife holder, the pouncing tool or the pen.

-
4. *Control Panel* : - The control panel includes 12 keys which can be used to control cutter activity, including remote mode for computer control, local mode for manual operation, and menu mode. Each control panel function is explained in Section 2.1.
 5. *Display*: - The 2x16 character display informs the user of the current status of the cutting process or actions that need to be taken.
 6. *Sensors*: - The sensors detect the absence of media to prevent the knife from damaging the cutting strip. When the cutter is turned on, the sensors cause the media to move all the way to the front edge of the platen.
 7. *Pinch rollers*: - The pinch rollers (one at each side) exert downward force through the media and onto the media sleeves. This squeezing between the pinch rollers and media sleeves is what allows the cutter to accurately advance and retract the media.
The D1600 Pro SL is equipped with two low pressure rollers in the middle to keep vinyl media flat.
 8. *Cutting strip*: - This reddish-brown strip prevents damage to the knife tip when the cutter is running and no media has been loaded. Because cutting is done on the cutting strip, it is essential that it remain intact.
 9. *Manual slitting knife*: - When the cutter is done cutting a graphic, move the media forward by pressing the  key. Use the manual slitting knife to cut the finished graphic free from the media roll. Leave the loaded media in place, ready for the next cut job.
 10. *Stand*: - A stand comes standard with the Gerber P2C 1600 cutter.

1.6 POWERING UP THE CUTTER

1.6.1 EARTHING (“GROUNDING”)



SAFETY WARNING

An insulated earth conductor must be installed as part of the branch circuit that supplies power to the wall outlet to which the cutter is connected. The earth conductor must have the same size, insulation material, and thickness as the earthed and unearthed branch-circuit supply conductors, but the insulating sheath should be green, or green with yellow striping.

The earth conductor described above must be earthed at the electrical distribution board, or, if power is supplied by a separate system, at the power supply transformer/motor generator set.

The wall sockets into which the cutter is plugged must be of the earthed type. The earth conductors serving said wall sockets must be properly connected to earth.



CAUTION

Before plugging in the cutter's power cord to a power source, make sure the cutter is set to the correct operating voltage (100 V, 120 V, 220 V, or 240 V AC).
(see section 3.2)

See Table 1-8 for the minimum and maximum operating voltages for the different voltage ratings.

To check the operating voltage setting, locate the power entry module (shown in Figure 1-1) on the cutter's rear panel. The power entry module shows four possible voltage settings (100 V, 120 V, 220 V and 240 V). A pin next to one of the voltage settings indicates the voltage setting currently selected for the cutter. If this setting does not match the voltage supplied to your site, you will have to change the voltage setting prior to powering up the cutter.

For information about the conversion of the cutter's operating voltage and the exact fuse ratings, see Section 3.2.

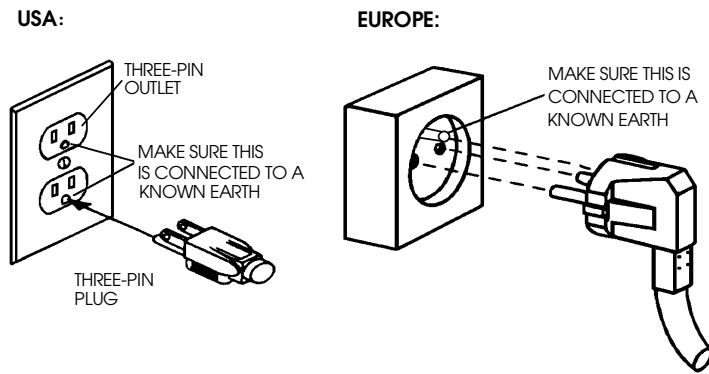

FIGURE 1-3:
EARTH CONNECTION



IMPORTANT OPERATIONAL TIP

Your cutter must only be used with a power outlet that is properly grounded to earth. Use of an unearthed outlet exposes the operator to the risk of electric shock and will also lead to malfunctioning of the cutter.

1.6.2. POWER UP PROCEDURE

➔ To power up the cutter, proceed as follows:

1. Be sure the cutter is securely attached to its stand.
2. Plug one end of the AC power cord into the AC power cord receptacle on the cutter's rear panel.
3. Plug the other end of the AC power cord into the wall socket.
4. Press the "I" side of the ON/OFF rocker switch on the rear panel to switch the cutter ON.
5. The message "INSERT MEDIA" is displayed on the LCD if no media is loaded and the pinch rollers are in the up position.

1.7 INSTALLATION OF A KNIFE, PEN OR POUNCING TOOL

1.7.1 KNIFE INSTALLATION



SAFETY WARNING

Your cutter uses razor-sharp knives. The knife blades may cause serious personal injuries if handled without proper care. Use extreme care when operating the cutter and when installing, removing or handling the knife!

➔ To set up your cutter for knife operation, proceed as follows:

1. Insert the knife blade into the knife holder as shown in Figure 1-4.

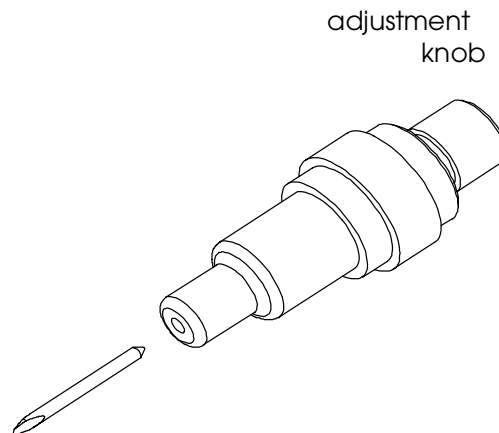

FIGURE 1-4
BLADE INSERTION

2. Set the knife blade length to zero by aligning the blade tip with the tip of the holder. An easy way of performing this is by holding the knife holder against your fingertip and gradually increasing the blade length by turning the adjustment knob until you feel the knife tip touching your fingertip.
3. Extend the tip of the blade according to the distance required for the desired cutting media (†), as shown in Figure 1-5. The blade should only extend beyond the knife holder sufficiently far to cut completely through the film layer while not piercing the backing, which would put the cutting strip at risk of being damaged.

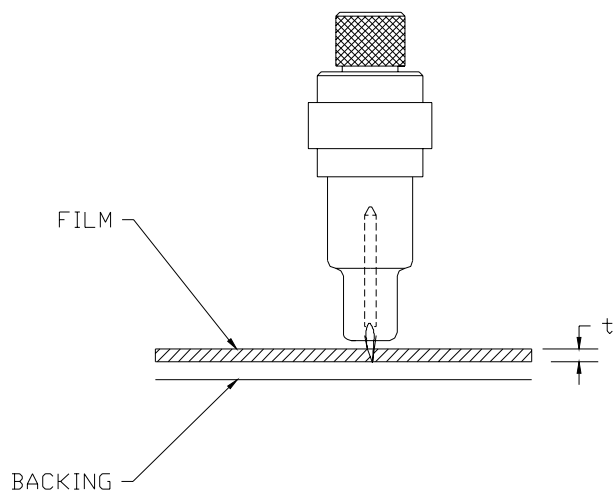

FIGURE 1-5
BLADE LENGTH ADJUSTMENT

4. Turn the cutting depth adjustment screw clockwise to increase the cutting depth. Turning the screw counterclockwise will decrease the cutting depth.

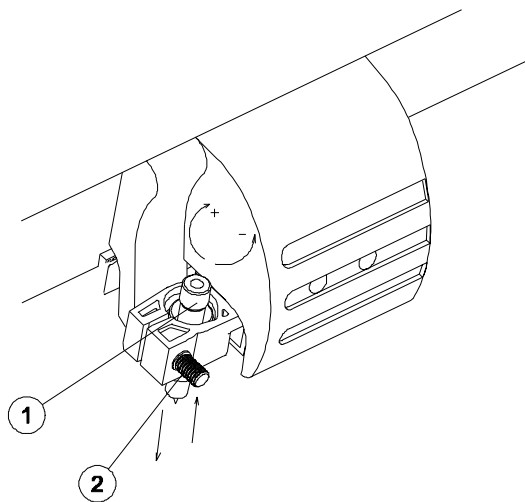

FIGURE 1-6
SETTING KNIFE DEPTH

5. To install the knife into the tool carriage:
 - Loosen the clamp screw (2) and place the knife holder in the clamp (1). Be sure that the knife holder is completely seated in the clamp.
 - Tighten the clamp screw.
6. Set the knife pressure as follows:

Press the  (MENU) key until the message "USER CONFIG 1" appears on the display.

```

↓ USER CONFIG 1
← →

```

Press the  jogging key until "KNIFE PRESSURE" is displayed.

```

↓ KNIFE PRESSURE
← *1200* 1=TEST

```

Press the  or  key to modify the knife pressure.

Press the  key to apply the new setting.

Press the **1** key to perform a knife depth test as illustrated in figure 1-7.

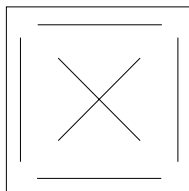

FIGURE 1-7
KNIFE DEPTH TEST PATTERN

The knife depth is set correctly when the test pattern is visible on the front side of the media backing but not on the back.

In general, you should increase the knife depth and knife pressure when using thicker types of vinyl.

NOTE

As the ideal knife pressure and depth settings depend on the thickness and type of media to be cut, adjusting the pressure and depth of the knife will require some practice. In general, the pressure should be increased when cutting thicker types of vinyl. Thinner vinyl usually requires lower knife pressure settings.

**CAUTION**

After setting the cutting depth and/or knife pressure, perform a thorough visual check of the knife blade, which can be seen protruding from the knife holder. Then perform a knife depth test cut on a scrap of vinyl.

DO NOT OPERATE THE CUTTER if the knife blade cuts through the media backing, as this will seriously damage the knife and the cutter's rubber cutting strip.

**CAUTION**

For most vinyl cutting operations, the tip of the blade should be barely visible at the bottom of the knife holder. If the tip of the blade is clearly visible, the knife's cutting depth will probably need to be adjusted.

To prevent damage to the cutter, check the depth of the blade tip and the quality of the cut whenever loading a different type of vinyl into the cutter.

1.7.2 PEN INSTALLATION

The Gerber P2C 1600 cutters can also accommodate a pen. After replacing the knife with a pen, the cutter can be used as a plotter to draw draft plots of new or existing designs on paper.

➔ To install the pen, proceed as follows:

1. Loosen the clamp screw and swinging the clamp arm back (refer to Fig 1-6). Remove the knife holder or pouncing tool.
2. Install the pen, close the clamp arm, and tighten the screw.
3. To configure the cutter for pen operation, press the  key.

Selecting pen operation disables the knife offset correction and changes the tip pressure from knife pressure to pen pressure. A small P (for "Pen") will be displayed in the upper right corner of the LCD.

1.7.3 INSTALLATION OF THE POUNCING TOOL

The Gerber P2C 1600 cutters can also be operated as pouncers by replacing the knife with a pouncing tool.

➔ To install the pouncing tool, proceed as follows:

1. Loosen the clamp screw and swing the clamp arm back. Remove the knife holder or pen (refer to Fig 1-6).
2. Install the pouncing tool, close the clamp arm, and tighten the screw.
3. To configure the machine for pouncing operation, press the  key.

Selecting pouncing operation disables the knife offset correction and changes the tip pressure from knife pressure to pouncing pressure.

1.8 LOADING MEDIA

The following procedures apply primarily when roll media is being used. When using a long sheet, roll the sheet up so that it resembles a media roll. The rolled sheet can then be aligned in the cutter in the same way as a media roll. When using short sheets, alignment is not as important. If the sheet is cut off perpendicularly, it can be aligned to the front border.

1.8.1 POSITIONING THE PINCH ROLLERS

The pinch rollers exert downward force on the drive sleeves. This pressure creates traction that allows the cut sheet or roll media to be moved along the X-axis (forward/backward).

Proper movement of the media will only occur if the pinch rollers are correctly positioned over the drive sleeves.

The pinch rollers are raised and lowered simultaneously by means of the pinch roller lever located on the right side of the cutter next to the control panel. The rollers must be raised before media can be loaded into the cutter.

When raised, the pinch rollers can be moved manually left and right along the pinch roller shaft. This way, they can be easily positioned in a detent (click position). The cutter should not be used unless all needed pinch rollers are secured in a detent to ensure optimum media traction.

When the pinch rollers are raised, the message "LOWER CAM ROLLERS" is displayed on the LCD.

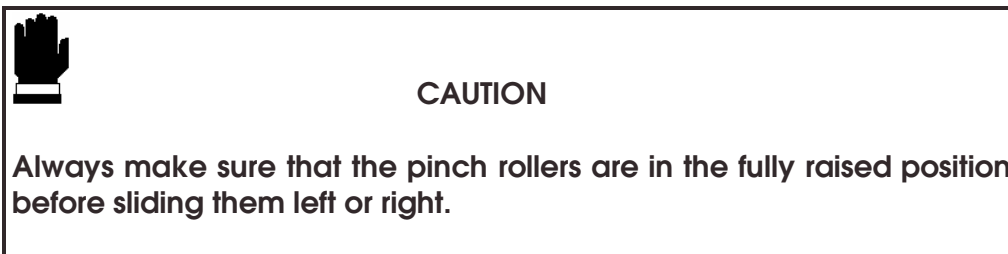

The pinch rollers **MUST** be positioned correctly and lowered onto the media before an automatic load sequence will be initiated. Make sure that the pinch rollers are positioned directly above the drive sleeves. The left pinch roller should be positioned in a detent (click position). The right pinch roller should be positioned somewhere along the wide drive sleeve, which has detents only at its extreme right and left ends. The drive drum will move the media only when the pinch rollers are lowered onto the sleeves.

Before lowering the pinch rollers, carefully check the position of the rollers in relation to the drive sleeves. When the pinch rollers are DOWN, they must run over the sleeves in order to ensure proper media traction. It is very important that the left and right edges of the media always rest on sleeves. Position the pinch rollers so that they are 3 to 15 mm (0.1" to 0.6") in from the edge of the media.

On the Gerber P2C 1600 cutter, two, three or more sleeves may be partly or fully covered, depending on the media width used. To ensure correct positioning of the pinch rollers, reference marks in the shape of inverted triangles have been provided on the head guide.

The center low-pressure roller is used to enhance media routing and keep the vinyl flat. Ideally, this roller should be positioned halfway between the two edge rollers but always over one of the drive sleeves.

The center low-pressure roller(s) can be in the raised position on the Gerber P2C D1600 cutters when media narrower than 600 mm is being cut.

1.8.2 FEEDING AND POSITIONING MEDIA

The following load procedure has been found to be very reliable. Adhere to these step-by-step instructions when loading media.

➔ To load media, proceed as follows:

1. Raise the pinch rollers by lowering the pinch roller lever located at the back of the cutter.

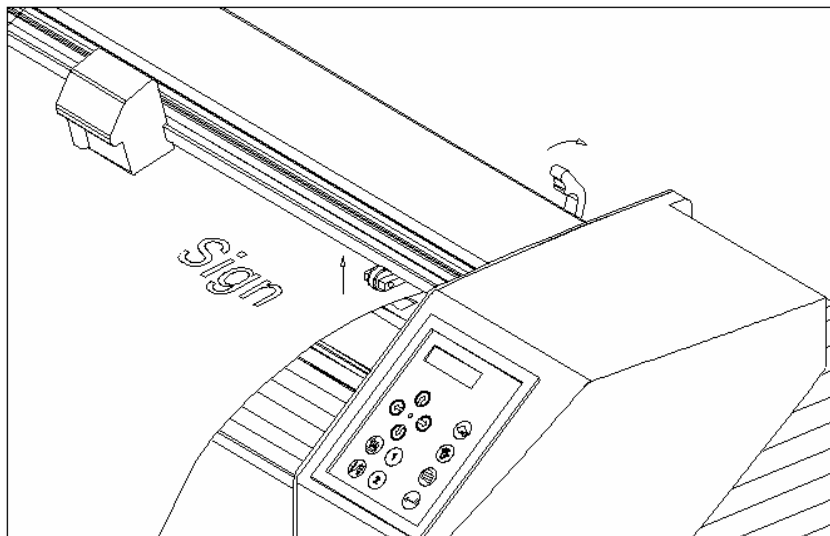

FIGURE 1-8:
MEDIA POSITIONING

2. When working with roll media, proceed by inserting a media flange at each end of the roll and then tighten the thumbscrews until the media roll is firmly gripped between the flanges. Make sure the flanges are firmly

pressed against the roll. Place the flanges on the media support rollers at the rear of the cutter.

3. Position the flanges on the support rollers at the rear of the cutter. Slide the two media guides under the media roll so that each flange rests in the groove in the guide. In this position, the media roll and guides can be shifted left and right.

Feed the media from the rear of the cutter.

Position the left edge of the media on the leftmost drive sleeve and then check to see whether the right edge of the media is positioned over the wide drive sleeve. If it is, the left pinch roller can be positioned in the detent above the leftmost sleeve. Then, the right pinch roller can be positioned somewhere over the wide drive sleeve according to the media width. The right pinch roller can be located anywhere between the two outer detent positions above the long drive sleeve. This flexibility allows a variety of media widths to be accommodated.

Should the above procedure fail to work because the media is too narrow to reach the long drive sleeve, try positioning the left media edge over the second drive sleeve in from the left. Then position the right media edge somewhere on the wide drive sleeve. Repeat this process if the media is still found to be too narrow by locating the left media edge over the third drive sleeve in from the left. Adjust the right edge of the media as described above.

Follow the same general procedure when loading media on the wider models of the Gerber P2C cutters, which have been provided with additional sleeves.

If necessary, continue to reposition the media until both edges are positioned over a drive sleeve.

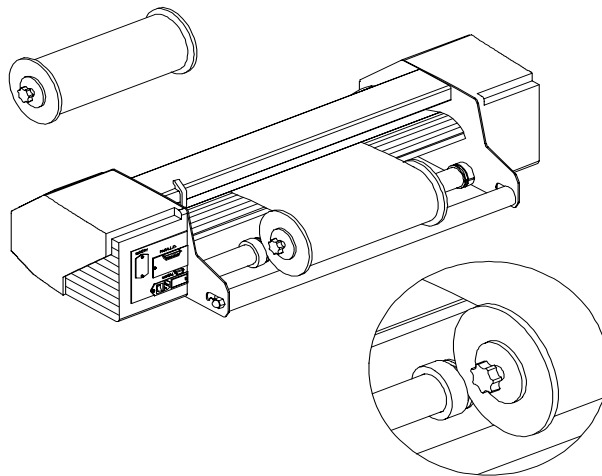

FIGURE 1-9:
FEEDING ROLL MEDIA USING MEDIA FLANGES

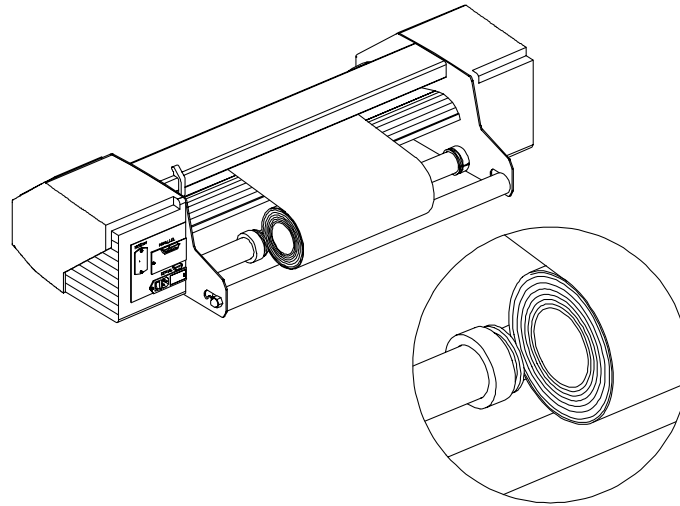

FIGURE 1-10:
FEEDING ROLL MEDIA WITHOUT USING MEDIA FLANGES

4. Make sure that the media follows a straight path from the roll to the cutting area. This can be accomplished by sliding the media guides left and right as needed along the media support rollers.
5. The pinch rollers should be positioned over the drive sleeves and about 3 to 15 mm (0.1" to 0.6") in from the edges of the media.

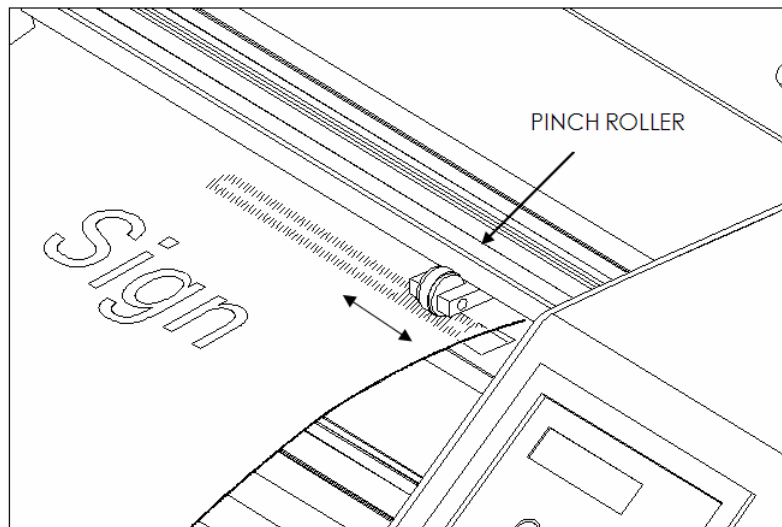

FIGURE 1-11
PINCH ROLLER POSITIONING

6. Raise the pinch roller lever to lower the rollers onto the media and drive sleeves. The tool carriage will automatically begin moving left and right to sense the usable media width.

NOTE

It is not necessary to pull the media manually from the roll. The cutter will unroll the media automatically during the load sequence.

7. The positioning and routing of sheet material is identical to that of roll media.
8. The cutter is now ready for the actual load procedure, which may be controlled from the control panel.

1.9 MEDIA LOAD PROCEDURE



SAFE OPERATION

Do not place any objects in front of, or behind, the cutter that could interfere with cutter operation. Make sure the media is free to move forward and back. Keep hands, hair, clothing and jewelry away from moving parts.

Turn the power on. The following message will appear on the LCD screen:

```
PLEASE WAIT
LOADING
```

The cutter will automatically start executing a minimal loading procedure consisting of:

- A media width measurement
- A 45° test
- A length of media is unwound equal to the width measured between the pinch rollers

When the cutter indicates that it is "ONLINE", it is ready to receive a file:

```
800mm/s 1209 K
.45mm ONLINE 1
```

When receiving a cut file, the cutter will automatically pull from the roll a length of media equal to the width of the pinch rollers. Media is then pulled successively from the roll in increments equal to the width of the rollers.

IMPORTANT

Tracking of longer signs is only guaranteed when the **full load procedure** is performed!

Proceed as follows to complete the full load procedure:

Press the  key and the following message will appear on the LCD screen:

```

SET ORIGIN
X=0 Y=yyyy

```

Press the  key again and the following message will appear on the LCD screen:

```

LOAD
1=ROLL 2=SHEET

```

Press the **1** key to load media from **a roll**. Press the **2** key to load media **in sheet form**.





If "sheet" is selected and the sensors are enabled, then the sheet is automatically loaded.

If "roll" is selected, the following display will appear on the LCD:

```

SET ORIGIN
X=0 Y=yyyy



```

Using the , , , and  jogging keys, the knife (i.e., the origin) can be repositioned to any location. Press the  key to confirm the selected point of origin.

```

MEDIA WINDOW

```

The media length needed for a task can be entered by pressing the  and  jogging keys.

```

MEDIA WINDOW
XXXX YYY

```

The XXXX-value is the media length as defined with the  and  jogging keys.

The YYY-value is the cuttable width of the media as measured by the cutter. Note: when the media length displayed is zero (0), the default media length will be used.

Press  to confirm the length and the cutter will start "shuffling" the vinyl in order to establish a track on the vinyl.

```

600mm/s 1209 K
.45mm ONLINE 1

```





The cutter is now ready to receive a file.

```
800mm/s 1209 K
.45mm *ONLINE 1
```

The cutter has been selected by the computer.

However, if you pressed , the default media length is displayed:

```
DEFAULT WINDOW
+ 2000 mm #
```

An XXXX-value appears. (2000mm is the default value.) The default values can be changed by pressing the  (+10),  (-10),  (-100), and  (+100) jogging keys.

Press  to confirm the length, and the cutter will start shuffling the vinyl in order to set a track on the vinyl.

```
800mm/s 1209 K
.45mm ONLINE 1
```

The cutter is now ready to receive a file.

```
800mm/s 1209 K
.45mm *ONLINE 1
```

The cutter has been selected by the computer.

When the built-in media sensors detect the end of the roll, the message **END OF MEDIA** will be displayed. The display will show the actual length of the loaded media.

If that length is sufficient, press **1** to **ACCEPT**.

If not, press **2** to **ABORT** and the media will automatically return to its origin.



CAUTION

When you accept the loaded area in sheet mode, the cutter will clip the sign to be cut in case of insufficient media. Compare the loaded media with the area needed for the sign!

SECTION 2

2 OPERATION

2.1 THE CONTROL PANEL

Figure 2-1 shows the control panel of the Gerber P2C 1600 cutters. The main functions of the liquid crystal display (LCD) and the control panel keys are explained in the following paragraphs.

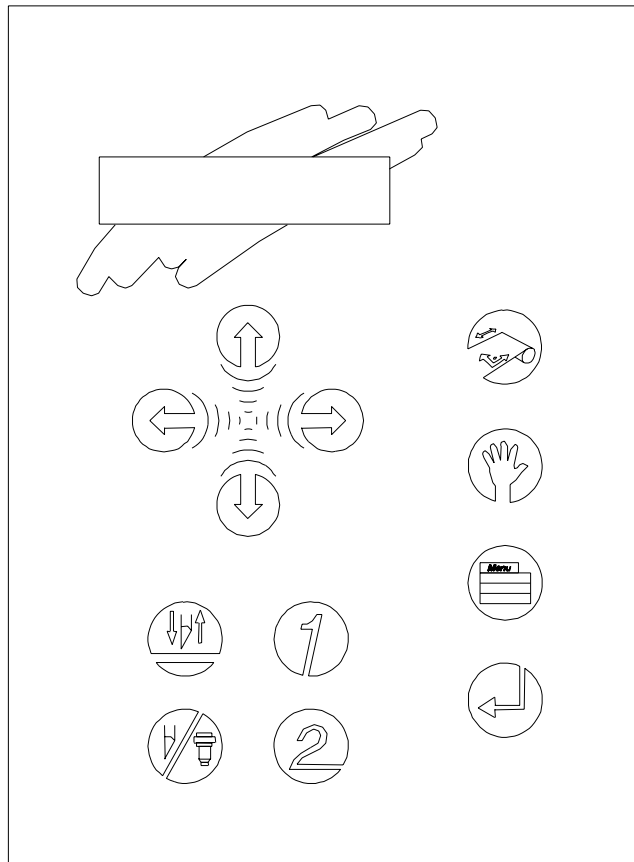







FIGURE 2-1:
CONTROL PANEL, GERBER P2C 1600

2.1.1 THE LIQUID CRYSTAL DISPLAY











The 32-character liquid crystal display (LCD) consists of two lines of 16 characters each. The LCD provides cutter status information during operations and displays menu options for the configuration of the cutter.

The contrast of the LCD can be adjusted from the control panel in order to ensure optimum readability under varying lighting conditions. Instructions for adjusting the LCD contrast are given in Section 2.6.11.

The various menu and submenu items are always presented in a loop. When the last item in the menu is displayed, pressing the appropriate key will automatically take you back to the first item in the same menu or submenu.

Next to the status messages and/or menu options displayed on the LCD, arrow symbols representing the , , , and  jogging keys and the  key will tell you what keys to press to go to the next menu item (top line of the display) or to the next value for a given submenu item (bottom line of the display).

2.1.2 THE RESET/LOAD KEY

The  key (RESET/LOAD) is used to move the origin, initiate a load sequence, reset the cutter, abort the cut in progress or recut the last file. When the  key (RESET/LOAD) is pressed, the cutter goes offline, suspends all operations in progress, and displays the RESET/LOAD menu. Press the  key until SET ORIGIN, LOAD, RESET, ABORT, SPECIAL LOAD or RECUT is displayed. To confirm RESET, ABORT or RECUT, press the  key (ENTER). To execute the SET ORIGIN instruction, move the knife origin using the , , , and  jogging keys and then press the  **key** (ENTER) to confirm the new origin position. Press the **1** or **2** key to initiate a load sequence for a ROLL or SHEET, respectively. Press the  **key** (ENTER) to initiate the SPECIAL LOAD instruction. Then position the knife tip directly over the origin-marker using the jogging keys. The cutter will return to ONLINE status should any of these instructions be terminated.

The SET ORIGIN instruction is used to move the knife origin.

The LOAD instruction is used to initiate a load sequence.

The RESET instruction performs a complete reset of the cutter.



The ABORT instruction simply cancels the cut in progress. Aborting a cut will not reset the cutter parameters; the parameters that had been selected for the cut remain in effect.

The SPECIAL LOAD instruction is used to initiate registration of the OPOS markers just before a contour cut is begun. See the section on OPOS for more information about contour cutting.

The RECUT instruction recuts the last file sent to the cutter (provided that it fit in the buffer).





When using the multiple recut function, the different copies will be cut in a way that minimizes media waste. The distance between the copies can be changed (See Section 2.4.18).

2.1.3 THE ONLINE KEY





The  key (ONLINE) toggles the cutter between online and offline operation. When the  key is pressed, the selected mode (ONLINE or OFFLINE) is displayed on the LCD.

Selecting OFFLINE suspends all operations in progress. Pressing the  key while the cutter is offline will return the cutter to online status and the suspended operation will resume.

While the cutter is offline, the following operations can be performed:

- Press the  or  jogging key to move the tool carriage to the left or right.
- Press the  or  jogging key to scroll the media forward (towards you) or backward (away from you). Scrolling the media is useful when it comes time to manually cut the graphic from the rest of the media.
- Press the  key (TOOL UP/DOWN) to raise or lower the active tool. The tool is raised automatically if it is not moved for approximately eight seconds.

2.1.4 THE MENU KEY

The  key (MENU) is used to select a menu. Pressing the  key will cause the cutter to go offline and suspend all operations in progress. Pressing the  key repeatedly will display the different menus one at a time. As the menu options are on a loop, pressing the  key when the last option is displayed will automatically return you to the first option.

The different menus are illustrated in Figure 2-2.

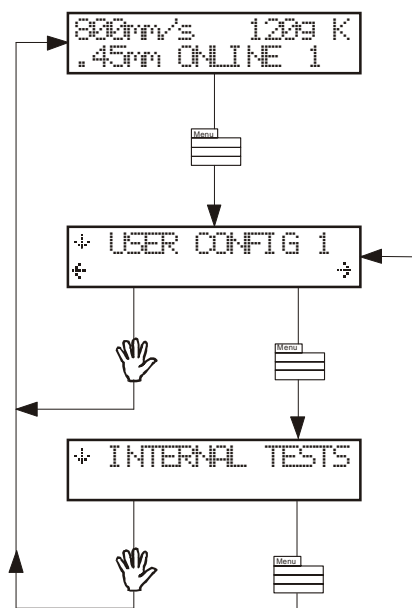





FIGURE 2-2:
GERBER P2C 1600 CONFIGURATION SUBMENUS

Press the  jogging key to select a menu by scrolling through the different options.

Press the  key (ONLINE) to exit the menus and resume the previous online operation.

Under normal conditions, the cutter is online; it may then be selected by the host computer for a cutting or plotting operation or deselected by the host computer. Pressing the , , or  key will cause the cutter to go offline in order to initiate another operation.

The contents of the different menus are summarized in Table 2-1.

MENU	DESCRIPTION
USER CONFIG 1 (->4)	Selects a given active cutter configuration from one of the four sets of configuration parameters stored in the cutter's memory
INTERNAL TEST	Activates one of the resident cutting plots provided for informational purposes.

TABLE 2-1:
CONTENTS OF THE GERBER P2C 1600 MENUS

2.1.5 THE ENTER KEY





The  key (ENTER) is used to select the item currently displayed on the LCD.

2.1.6 THE 1 AND 2 KEYS **1 - 2**



The use of the **1** and **2** keys varies according to the operation in progress; their use is displayed on the LCD as appropriate.

2.1.7 THE JOGGING KEYS

Use of the jogging keys varies according to the operation in progress.





For example, when working in the USER CONFIG menu, the  or  jogging key is used to select the new user number and the  or  jogging key is used to go to the previous or next menu item.

2.1.8 THE TOOL UP/DOWN KEY

The  key (TOOL UP/DOWN) is used while the cutter is offline to raise or lower the tool. Pressing the  key once will lower the tool onto the media. Pressing the  key again will raise the tool.

If the tool is not moved for approximately eight seconds, it will be raised automatically.

2.1.9 THE TOOL SELECT KEY

The  key (TOOL SELECT) is used to select knife, pen or pouncing operation. To temporarily change the tool, press the  key, then press the  or  jogging key until the desired tool appears on the second line of the LCD. Press the  key to confirm the tool. An asterisk (*) appears next to the selected tool. When the cutter is powered on the next time, the default tool will be selected. See Section 2.4.4 for information about setting up the default tool.

2.2 NORMAL OPERATION

The term "normal operation" covers online operation, offline operation, and local operation, i.e. the three types of operation for actual cutting or plotting. They are explained in further detail in the following paragraphs.

2.2.1 ONLINE AND OFFLINE

Online and offline are two important concepts when using the Gerber P2C 1600 cutters. The cutter is online only when the following message is displayed on the LCD:

```
800mm/s   120g K
.45mm ONLINE 1
```

This display message should be read as follows:

800 mm/s	=	velocity
120 g	=	knife pressure, pen pressure or pouncing pressure
K	=	knife operation (K), pen operation (P)
.45 mm	=	knife offset
ONLINE	=	cutter is ready to receive data
1	=	current user configuration

In all other cases, the cutter is offline.

When online, the cutter can be addressed by the host computer, which means that the cutter will execute cutting or plotting instructions issued by the host computer's application software. The host computer will first issue a SELECT sequence to the online cutter, and the message "*ONLINE" will be displayed on the LCD. The asterisk indicates that the host is in communication with the cutter: i.e., the cutter is now "selected" by the computer.

When the cutter is online and ready to receive instructions from the host computer, it will remain deselected until actual instructions from the computer are received. When the cutter is online, but has not been selected by the host computer, the message "ONLINE" is displayed on the LCD, without the asterisk.

For normal cutting operations, the cutter **MUST** be online, so that it can receive instructions from the host computer and the cutting/plotting software.

When the cutter is online, but has not been selected by the host computer, the following conditions must be met:







- The cutter must be powered ON.
- Media must be loaded. For detailed media loading instructions, see Section 1.8.
- The proper tool must be installed.
- The cutter must be connected to the host computer via a USB, RS-232-C link or a parallel interface.
- The cutter must be configured for the scheduled operation.

To put the cutter offline, press the ,  or  key. Pressing any of these keys will suspend the current cutting/plotting operation until the cutter is again put online.

2.2.2 LOCAL OPERATION

Local operation is only possible while the cutter is offline. Local operation means that the cutter is operated directly by the operator via instructions entered on the control panel.

➔ To work in local operation mode, proceed as follows:



1. If the cutter is still online, press the  key once to select offline.
2. To move the carriage left or right, press the  or  jogging key.
3. To scroll the media forwards (towards you) or backwards (away from you), press the  or  jogging key.
4. Press the  key to move the tool head up or down.
5. Press the  key to end local mode and put the cutter online again.

2.3 THE USER CONFIG MENU

The USER CONFIG(uration) menu gives access to different submenus that allow you to configure the cutter's operating parameters. Access to some of the submenus will be determined by the plotting language being used.

Four different user configurations can be saved. The selected configuration number is displayed on the LCD next to the USER CONFIG message. These four USER CONFIG 1(->4) menus are maintained independently.

➔ To select another **configuration number**, proceed as follows:







1. Power on the cutter.
2. Press the  key until USER CONFIG 1(->4) is displayed.
3. Press the  or  jogging key until the desired configuration number is displayed next to USER CONFIG.

NOTE

Before altering any of the items in the USER CONFIG menu, make sure that you have previously selected the correct configuration number in the USER CONFIG 1(->4) menu.

Figure 2-3 shows the USER CONFIG submenus.

➔ To select and alter a configuration parameter, proceed as follows:

1. Power on the cutter.
2. Press the  key until USER CONFIG 1(->4) is displayed.
3. Press the  or  jogging key until the desired submenu is displayed on the first line of the LCD.
4. Press the  or  jogging key until the desired value is displayed on the second line.
5. Press the  key to confirm the selection. An asterisk (*) will be displayed next to the new setting. (An * is always displayed next to the active value.)

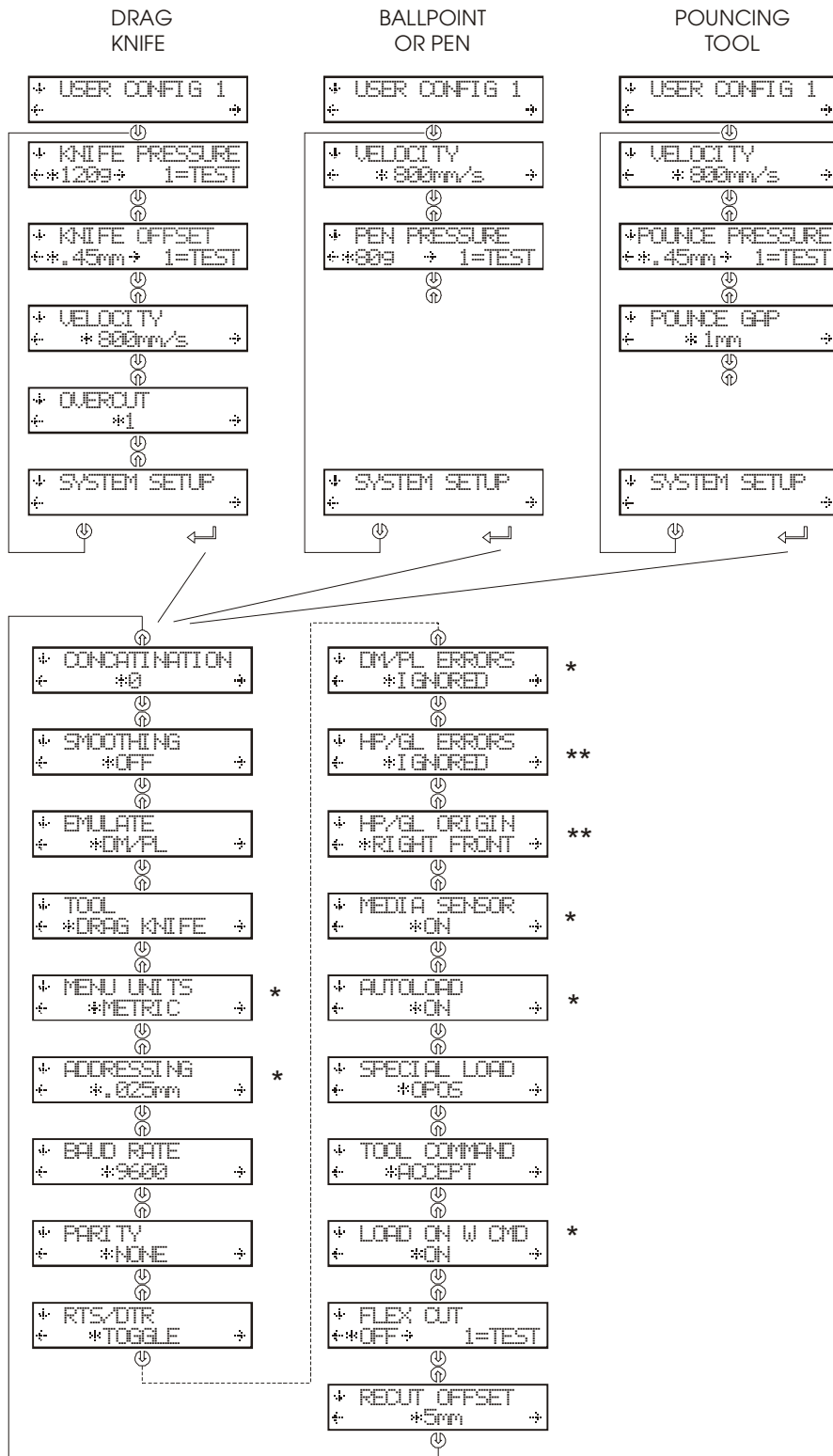

* in DM/PL only

** IN HP-GL AND HP-GL/2 ONLY

FIGURE 2-3:
FLOWCHART SHOWING FACTORY PRESET MENU SETTINGS

2.3.1 KNIFE PRESSURE

The KNIFE PRESSURE submenu is used to set or modify the cutting pressure of the knife.

The default knife pressure value is 120 grams.

The knife pressure can be set between 0 and 400 grams.

The knife pressure value is set in 5-gram increments.

The active knife pressure value is marked with an asterisk (*) on the LCD.

Knife pressure setup is explained in detail in section 1.7.1.

2.3.2 KNIFE OFFSET

The KNIFE OFFSET submenu is used to set or modify the distance between the tip of the knife and the axis.

The default knife offset value is .45 mm.

The value can be set between 0 and 1 mm.

Make sure that the selected knife offset value is appropriate for the knife being used.

Some fine-tuning may be necessary because of the knife's mechanical tolerances. To verify the knife offset, a test can be cut by pressing the **1** key.

If the offset value is set too low, the rectangles will not close.

If the offset value is set too high, the rectangles will be distorted.

The offset test is illustrated below.

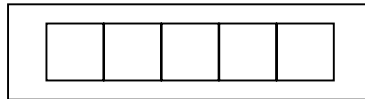

2.3.3 POUNCING PRESSURE

The POUNCING PRESSURE submenu is used to set or modify the amount of pressure exerted upon the pouncing tool.

The default pouncing pressure value is 120 grams.

The pouncing pressure can be set between 0 and 400 grams.

The pouncing pressure value is set in 5-gram increments.

The active pouncing pressure value is marked with an asterisk (*) on the LCD.

Pouncing pressure setup is explained in detail in section 1.7.3.

2.3.4 VELOCITY

The VELOCITY submenu is used to set or modify the velocity of the tool.

The default velocity is 800 mm/s (20 ips).

The velocity can be set between 50 mm/s (2 ips) and 1000 mm/s (40 ips).

2.3.5 OVERCUT

The OVERCUT submenu enables you to establish an overcut to facilitate weeding.

The default overcut value is 1.

The overcut setting can be disabled (=0) or set to any value between 0(=off) and 10. One unit is about 0.1 mm or 0.004".

The current overcut value is marked with an asterisk (*) on the LCD.

2.3.6 POUNCING GAP

The pouncing gap submenu is used to set or modify the distance between the pounced holes. Pouncing gap only applies when the machine is in pounce mode.

The default pouncing gap is 1 mm.

The value can be set between 0 and 50 mm.

The current pouncing gap value is marked with an asterisk (*) on the LCD.

2.3.7 SYSTEM SETUP

The SYSTEM SETUP submenu includes menu items normally needed only during initial setup when the cutter is made to communicate with the computer and software.

Press the  key to access the different submenu items, which are explained in section 2.4.

2.4 SYSTEM SETUP

Refer to Figure 2-3.

2.4.1 CONCATENATION

The CONCATENATION feature increases the speed and cut quality when high resolution data is being cut. However, when changing back to normal characters, concatenation should be deactivated by setting the parameter to 0.

The active concatenation value is marked with an asterisk (*) on the LCD.

2.4.2 SMOOTHING

The SMOOTHING feature applies to graphics that have curves made up of many short vectors. SMOOTHING smoothes the vectors to achieve a more rounded appearance.

SMOOTHING is set to OFF by default.

2.4.3 EMULATE

The EMULATE submenu is used to select the cutter's active cutting/plotting language.

The Gerber P2C 1600 cutters support DM/PL, HP-GL and HP-GL/2.

The active plotting language is marked with an asterisk (*) on the LCD.

NOTE

The cutter's active cutting/plotting language **MUST** match the active cutting/plotting language set in the cutting software.

Always select a language that is supported by the host computer's cutting software.

Whenever possible, select the DM/PL menu option which sets the active cutting/plotting language to Houston Instrument Digital Microprocessor/Plotting Language (DM/PL). This selection will allow the cutter to operate with DM/PL-based cutting/plotting software. This language, having special command extensions for cutting, normally gives superior cutting performance.

Select the HP-GL menu option to set the active cutting/plotting language to Hewlett-Packard Graphics Language. The cutter will emulate an HP model 758XB plotter (with selectable origin, see 2.4.12).

2.4.4 TOOL

The TOOL submenu is used to select the default tool at power up.
Select PEN to configure the cutter for plotting operations.
Select DRAG KNIFE to configure the cutter for cutting operations.
Select POUNCING TOOL to configure the cutter for pouncing operations.
To temporarily select a tool other than the default tool, see section 2.1.9.

2.4.5 MENU UNITS

The MENU UNITS submenu allows English or metric menu units to be selected for DM/PL operations. Menu units in HP-GL & HP-GL/2 are always in metric.

English units are the default setting for models sold in the US.
Metric units are the default setting for models sold in Europe.
The setting for the active menu units is marked with an asterisk (*) on the LCD.

2.4.6 ADDRESSING

The ADDRESSING submenu is used to select the cutter's default DM/PL user-addressable resolution.

The user-addressable resolution can be set to 0.025 mm or 0.1 mm when using metric menu units, or 0.001" or 0.005" when using English menu units.

The default addressing resolution is 0.025 mm (metric), 0.001" (English).

In HP-GL & HP-GL/2, the addressing is fixed at 0.025 mm.

The active resolution value is marked with an asterisk (*) on the LCD.

2.4.7 BAUD RATE

The BAUD RATE submenu is used to set or modify the baud rate for RS-232-C serial communication between the cutter and the host computer.

The baud rate can be set to any of the following values: 2400, 4800, 9600, 19200 or 38400 bps.

The default baud rate is 9600 bps.

The active baud rate value is marked with an asterisk (*) on the LCD.

NOTE
The cutter's baud rate setting MUST match the host computer's baud rate setting.

2.4.8 PARITY

The PARITY submenu is used to set or modify the byte format and parity type for RS-232-C serial communication between the cutter and the host computer.

The default parity setting is bit 8 = 0 (8 data bits, no parity, the 8th bit being a low bit). The parity can be set to any of the following values:

LCD information	Parity setting	Remarks
BIT 8 = 0	8 data bits, no parity	bit 8 = low (0)
BIT 8 = 1	8 data bits, no parity	bit 8 = high (1)
EVEN	7 data bits, 1 parity bit	parity bit = even
ODD	7 data bits, 1 parity bit	parity bit = odd

The active parity setting is marked with an asterisk (*) on the LCD.

NOTE

The cutter's parity setting **MUST** match the host computer's parity setting.

2.4.9 RTS/DTR

The RTS/DTR submenu controls the Request To Send (RTS) and Data Terminal Ready (DTR) signals for the cutter's RS-232-C serial communications interface for hardware handshaking.

RTS/DTR can be set to TOGGLE (hardware handshaking) or HIGH (software handshaking).

The RTS/DTR default value is TOGGLE.

The active handshake setting is marked with an asterisk (*) on the LCD.

2.4.10 DM/PL ERRORS

The DM/PL ERRORS submenu is used to determine whether or not different DM/PL errors, such as illegal plot commands, invalid parameter ranges or communication errors will be displayed on the LCD. This menu will only be displayed if PLOT LANGUAGE is set to DM/PL.

The DM/PL ERRORS submenu can be set to REPORTED or IGNORED.

This feature is activated by selecting REPORTED, and is normally used only when attempting to debug a communication link between the cutter and the host computer.

After the communication link has been debugged, select IGNORED to disable the feature.

The active setting is marked with an asterisk (*) on the LCD.

2.4.11 HP-GL ERRORS

The HP-GL ERRORS submenu is used to determine whether or not different HP-GL errors, such as illegal plot commands, invalid parameter ranges or communication errors will be displayed on the LCD. This menu will only be displayed if PLOT LANGUAGE is set to HP-GL (See Paragraph 2.4.3).

The HP-GL ERRORS submenu can be set to REPORTED or IGNORED.

The feature is activated by selecting REPORTED, and is normally used only when attempting to debug a communication link between the cutter and the host computer.

After the communication link has been debugged, select IGNORED to disable the feature.

The active setting is marked with an asterisk (*) on the LCD.

2.4.12 HP-GL ORIGIN

The HP-GL ORIGIN submenu will only be displayed if the PLOT LANGUAGE is set to HP-GL. (See Paragraph 2.4.4). The HP-GL ORIGIN submenu is used to set the origin in the center (see HP-GL 758x) or the bottom-right corner (see HP-GL 7475) of the loaded media.

The HP-GL ORIGIN option can be set to RIGHT_FRONT or CENTER.

If the cut is found to be incomplete, and is wholly located in the upper left corner of the media, then change the HP-GL ORIGIN setting to RIGHT FRONT.

If the cut is found to be incomplete, and is wholly located in the lower right corner of the media, then change the HP-GL ORIGIN setting to CENTER.

The active setting is marked with an asterisk (*) on the LCD.

2.4.13 MEDIA SENSOR

The MEDIA SENSOR submenu is used to activate or deactivate the media sensors. The sensors detect the presence and absence of media to prevent damage to the cutting strip and knife tip.

The active setting is marked with an asterisk (*) on the LCD.

2.4.14 AUTOLOAD

The AUTOLOAD option allows the user to control how vinyl is pulled from the roll. When AUTOLOAD is ON, the cutter will automatically unroll the vinyl as needed. When AUTOLOAD is OFF, the user should manually unroll sufficient vinyl before beginning to cut.

The default AUTOLOAD setting is ON. The best results and performance are guaranteed when using this setting.

The active setting is marked with an asterisk (*) on the LCD.

2.4.15 TOOL COMMAND

TOOL COMMAND is used to determine whether the DM/PL and HP-GL pen/knife-select commands (the P and SP commands, respectively) are ignored or accepted.

When the TOOL COMMAND option is set to "ACCEPT", the P or SP commands will change the selected tool in the cutter according to the suffix that follows the pen/knife command. When a P2 command is sent, the cutter's LCD will prompt the user with the following message: "INSERT PEN". When the TOOL COMMAND option is set to "IGNORE", the pen/knife commands are ignored.

The default setting is "ACCEPT".

The active setting is marked with an asterisk (*) on the LCD.

2.4.16 LOAD ON W CMD

The LOAD ON W CMD submenu will only be displayed if the PLOT LANGUAGE is set to DM/PL (See Paragraph 2.4.4). When receiving the DM/PL Window-command (W-command), LOAD ON W CMD determines whether media is loaded apart from the scaling function. In addition to scaling, the W-command is very useful when cutting long signs. Media loading will go more smoothly with the W-command because sufficient media will be pulled from the roll at once. Then, even when AUTOLOAD is off, there is no need to unroll the media manually.

2.4.17 FLEX-CUT

FLEX-CUT can be set to OFF, Mode 1 or Mode 2. When set to Modes 1 or 2, the cutter will alternately cut one length with full pressure and one length with reduced pressure. FLEX-CUT offers the advantage of cutting completely through the material while, at the same time, allowing the material to stay together by means of small media bridges.

MODE 1 is the quickest mode, but is less precise because the pressure changes during the cutting. MODE 2 is considerably slower than Mode 1, but at the same time it offers greater precision because the cutter stops at every change of pressure. Pressing the **1** key will activate the configuration menu, which allows you to set the cutting pressure and cut length.

1. CUT LENGTH

This parameter determines the length that will be cut with full pressure. By pressing the **1** key, the FLEX-CUT test pattern will be cut.

2. FLEX-CUT LENGTH

This parameter determines the length that will be cut with reduced or no pressure. By pressing the **1** key, the FLEX-CUT pattern will be cut.

3. FLEX PRESSURE

This parameter determines the pressure of the FLEX-CUT LENGTH. By pressing the **1** key, the FLEX-CUT test pattern is cut.

2.4.18 RECUT OFFSET

The RECUT OFFSET submenu is used to set or modify the distance between graphics when making multiple recuts.





The distance can be set between 0 and 255 mm.

The default recut offset value is 0 mm.

The active recut offset value is marked with an asterisk (*) on the LCD.

2.5 INTERNAL TESTS MENU

➔ To access an internal cut, proceed as follows:

1. Power on the cutter.
2. Load cutting or plotting media.
3. Install a knife or pen.
4. Press the  key until INTERNAL TESTS is displayed. Press the  jogging key.
5. Press the  or  jogging key until the desired internal plot is displayed.
6. To perform the plot, press the  key.

To exit this menu and go to another menu, press the  key until the desired menu is displayed.

Press the  key to exit all menus and return the cutter to online status.

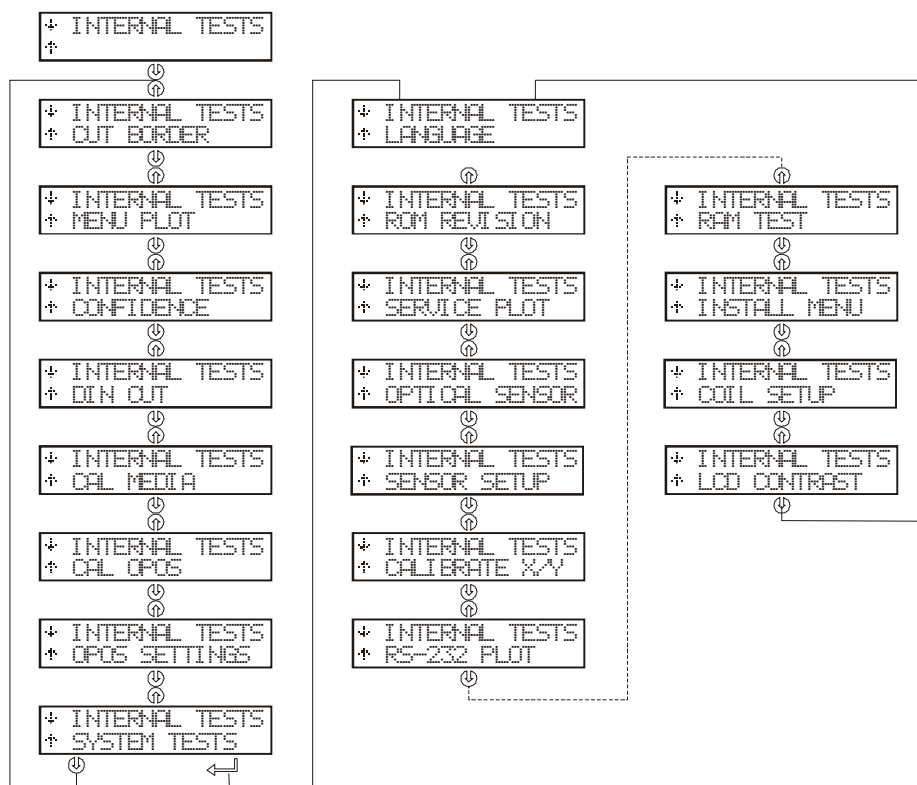

FIGURE 2-4:
INTERNAL TESTS SUBMENUS

2.5.1 CUT BORDER

CUT BORDER is used to cut the border of the media area as defined during the load sequence. This function can be used to verify the exact cutting area.

2.5.2 MENU PLOT

MENU PLOT produces a hard copy of the present cutter configuration, i.e. the parameter settings in the USER CONFIG submenus described in Section 2.3. The plot is organised by menu categories to show the current values for the various USER CONFIG 1(->4) configurations. To run this plot, load a sheet of plotting paper and install a pen.

NOTE

It is strongly recommended that a MENU PLOT be plotted each time the cutter configuration is altered. The resulting plot should be kept with the cutter documentation in order to provide other users with details about the unit's actual configurations.

2.5.3 CONFIDENCE CUT

The CONFIDENCE cut performs an electrical and mechanical test of the cutter to make sure that the cutter is fully operational. A sheet of media at least A3/A- size should be used for this plot.

2.5.4 DIN CUT

The DIN CUT performs an electrical and mechanical test of the cutter to check cut quality. It also provides the user with feedback on knife setting, knife pressure, knife offset, and cutting depth.

This cut is always run as a DIN A4 portrait/A-size image, regardless of the actual size of the loaded media. If the loaded media is smaller than DIN A4/A-size, part of the outer box will be clipped (not cut). This cut is always executed in the sequence prescribed by the ISO DIN standard.

2.5.5 CAL. MEDIA

CALIBRATION MEDIA is used to calibrate the sensitivity of the Optical Positioning System (OPOS) sensor.

This calibration is normally done at the factory. Run this test when the cutter fails to read the markers on a certain type of media.

First, print a black square measuring at least 4x4cm on the media that will be used. Be sure to use the same ink that will be used when creating the registration markers. Leave an area of blank media around the square that extends out at least 4cm in each direction.

Press the  key to perform the test. Then follow the instructions on the LCD.





2.5.6 CAL. OPOS

CALIBRATION OPOS is used to calibrate the Optical Positioning System (OPOS). This calibration is normally done at the factory. When the system is no longer working precisely, a calibration test must be performed. Calibration determines and records the exact distance between the knife tip and the sensor.

Press the  key to perform the test. Then follow the instructions on the LCD.

2.5.7 OPOS SETTINGS

The OPOS SETTINGS sub-menu is used to change the different OPOS parameters.

Press the  key to change the parameters. Then use the  or  jogging key to scroll through the different parameters. Change the values with the  or  jogging key. The different OPOS parameters are explained in the special section about OPOS.

2.5.8 SYSTEM TESTS



The SYSTEM TESTS submenu includes settings that are occasionally needed to adjust the cutting process.

Press the  key to access the different submenu items. Section 2.6 below further explains SYSTEM TESTS.

2.6 SYSTEM TESTS

The SYSTEM TESTS submenu consists of a special set of procedures that are not required for normal cutter operation. Field service personnel, however, will occasionally use the SYSTEM TESTS menu. When in SYSTEM TESTS, the cutter is fully operational and performs as described in this manual.

2.6.1 LANGUAGE

The MENU LANGUAGE submenu is used to set or modify the dialogue language on the LCD. Press the  or  jogging key until the desired language is displayed on the LCD. Press  to apply the new setting.

The information on the LCD can be displayed in English, French, German, Spanish, Italian or Dutch.

2.6.2 ROM REVISION

Press the  key to view information about the cutter's ROM revision. This information is often helpful to technicians when diagnosing problems over the telephone.

2.6.3 SERVICE PLOT

The SERVICE PLOT provides information about the cutter, which is helpful when requesting service. The SERVICE PLOT is always plotted at the same size and should be performed with a pen on paper.

The plot shows the cutter's model number, the revision numbers of the installed Read Only Memory (ROM) circuits, the selected baud rate, the resolution, and the buffer (memory) size.



CAUTION

The following test procedures are normally restricted to Gerber Field Service Personnel.

2.6.4 OPTICAL SENSOR

OPTICAL SENSOR is used to check whether or not the OPOS sensor is functioning properly. If the sensor is positioned over black media, the sensor output should be High (above 1500). If the sensor is positioned over white media, the sensor output should be low (below 400).

2.6.5 SENSOR SETUP

SENSOR SETUP is used to check whether or not the front and rear media sensors are functioning properly, and whether the switching levels of these sensors are set correctly.

2.6.6 CALIBRATE X/Y

CALIBRATE X/Y cuts two perpendicular lines in the media. The user then measures these lines manually and the results entered through the control panel.

For example, if the LCD indicates that one of the lines should measure 100 mm, but manual measurement indicates 105 mm, then 105 mm can be entered for that particular line by which the system will be calibrated.

2.6.7 RS232 TEST

The RS232 TEST verifies the cutter's RS-232-C serial communications (transmit data, receive data, and hardware handshaking) circuits. This test does not require that a pen, knife or media be loaded.

➔ To run the RS-232-C test, proceed as follows:

1. Unplug the RS-232-C data cable from the rear panel of the cutter.
2. Use a loopback test cable to connect pin 2 of the cutter's data connector to pin 3; connect pin 7 to pin 8.
3. With RS232 TEST displayed, press the ENTER key. The cutter will start transmitting and receiving data at all available baud rates and parity settings. The length of the transmissions will vary because of the different baud rates used. The unit then checks the hardware handshake lines.
4. Upon completion of the test, remove the loopback test cable from the cutter rear panel RS-232-C connector.
5. Reattach the RS-232-C data cable to the connector.

2.6.8 RAM TEST

This test completely checks the RAM bit for bit.

The cutter will not respond when this test is in progress. After this test is complete, power the cutter off and then back on.

2.6.9 INSTALL MENU

The INSTALL MENU procedure restores the factory-defined menu settings in all four USER CONFIG menus. This procedure can be performed without a tool or media.

2.6.10 COIL SETUP

This procedure is used to calibrate the knife and pen pressures, and to set the knife and pen "landings".

After calibration, the values are saved in the system's non-volatile RAM.

A tension gauge of ± 100 gr and ± 500 gr is required to execute this test.

The desired pressure appears in the upper line of the display. The bottom line of the display indicates the value that has to be sent to the head in order to reach the desired pressure (this value is between 0 and 127).

2.6.11 LCD CONTRAST

The LCD CONTRAST submenu is used to adjust the contrast (or intensity) of the liquid crystal display on the control panel.

Press the  or  jogging key to increase or decrease the contrast, then press  to apply the new setting.

SECTION 3

3 GENERAL INFORMATION



3.1 MAINTENANCE & CLEANING

The Gerber P2C 1600 cutters have a number of sliding surfaces made of smooth metals and plastics. They are virtually friction-free and require no lubrication. They will, however, collect dust and lint that may affect the performance of the cutter. Keep the cutter as clean as possible by using a dust cover. When necessary, clean the unit with a soft cloth dampened with isopropyl alcohol or mild detergent. Do not use abrasives.

3.1.1 CLEANING THE DRIVE SYSTEM

With time, the sleeves of the drive drum may become clogged with accumulated residue from the media. This situation may affect traction, as the media will tend to slip between the pinch rollers and the drive sleeves.

➔ To clean the drive sleeves, proceed as follows:

1. First, disable the sensors through the cutter's control panel or by simply covering them up (see 2.4.14 Media Sensor).
2. Put the cutter into local operation mode (see Section 2.2.2). Local operation will allow you to use the control panel's jogging keys even when no media is loaded.
3. Remove the backing from a piece of vinyl. Place the vinyl between a pinch roller and drive sleeve with the tacky side down. Raise the pinch roller lever to lower the pinch rollers. See Figure 3-1 below.
4. Use the  and  jogging keys to move the piece of vinyl back and forth several times until all residue is removed from the drive sleeves.
5. Lower the pinch roller lever and remove the piece of vinyl.
6. Repeat steps 3 through 5 for the other drive sleeves.
7. Set the cutter's power switch to OFF.

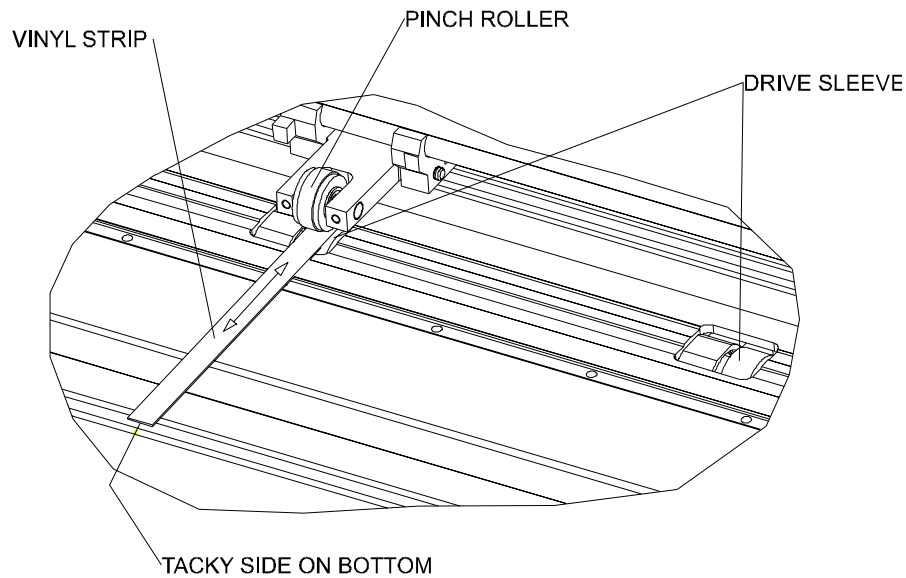

FIGURE 3-1:
CLEANING OF THE DRIVE SLEEVES

3.1.2 CLEANING THE SENSORS

After a while, the sensors may become dirty with accumulated residue from the media that may cause the cutter to malfunction.

➔ To clean the sensor area, proceed as follows:

1. The sensors are located on the right side of the cutter, one on the front platen and another on the rear platen.

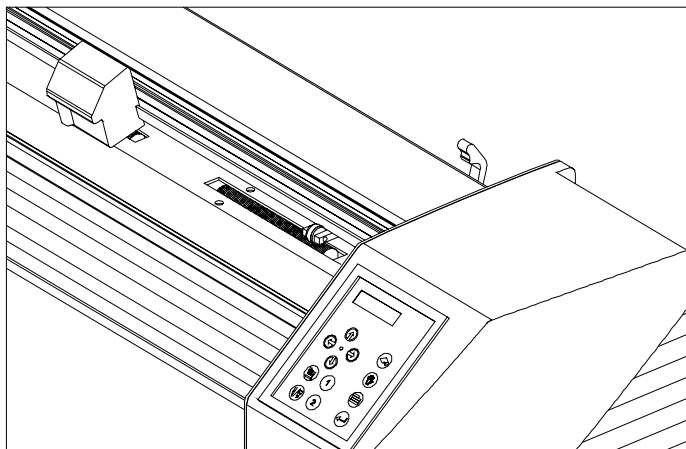

FIGURE 3-2:
LOCATION OF THE SENSORS

2. Wiping the sensors periodically with a cotton swab should suffice to keep them clean.

3.2 OPERATING VOLTAGE CONVERSION

The power entry module cover shows four possible AC voltage settings (100 V, 120 V, 220 V and 240 V). The hole with the pin indicates the cutter's active voltage setting. If this setting does not match the voltage supplied to your site, you must change the voltage ***BEFORE*** powering on the cutter.

When changing the voltage setting, you will also have to change the fuses as appropriate for the voltage.

To change the fuse(s), remove the fuse(s) from the fuse box behind the cover plate of the power entry module.

For 100 or 120 V AC operation, use only a 1.25 A Slo-Blo.

For 220 or 240 V AC operation, use only a 0.6 A Slo-Blo.

NOTE

Always make sure that you are using the correct fuses for your voltage selection.

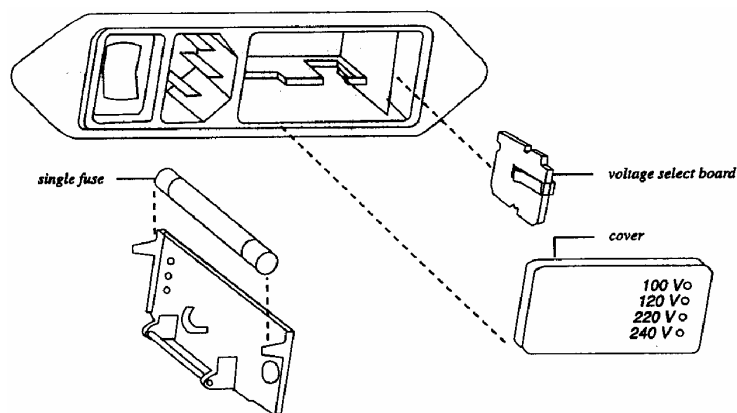

FIGURE 3-3
POWER ENTRY MODULE

SECTION 4

4 INTERFACE

4.1 INTRODUCTION

This section describes the signal connections for communication between your cutter and the host computer. When connecting the cutter to the host computer, always proceed as follows:

1. Refer to the documentation provided with your cutting/plotting software, and check the recommended cabling specifications.
2. If the documentation does not contain specific cabling instructions, use the Gerber cable specifications recommended for your computer.

The Gerber P2C 1600 cutters come equipped with serial, parallel, and USB connectors. If more than one port is connected at the same time, the port that receives data first will stay active and the others will be deactivated. The deactivated ports can only be reactivated by restarting the cutter.

Connecting more than one of the three communication cables to the cutter at a time can result in communication errors.

4.2 RS232 INTERFACE NOTES

4.2.1 SYSTEM SETUP

This section explains the process of configuring the serial port on your computer so that it will communicate with the cutter. This method applies only if serial (not USB or Parallel) is the chosen means of communication and requires that the computer is running the WIN95 or newer operating system.

→ To set up your system, proceed as follows:

1. Press the "Start" Button and select "Settings", followed by "Control Panel". Press on the "System" icon and select the "Device Manager" tab. Select the port that is connected to the cutter and click on the "Properties" button. Select the "Port Settings" tab to set the port settings.

2. The cutter's default settings are as follows:

- Baudrate : 9600 (see 2.3.8.)
- Data Bits : 8
- Parity : None (see 2.3.9.)
- Stop Bits: 2
- Flow Control : Hardware

4.2.2 SERIAL INTERFACE CONNECTOR ON THE CUTTER

RS-232C Serial Interface Connector		
<i>Pin n°</i>	<i>Signal</i>	<i>Description</i>
1	NC	Not Connected
2	RXD	Receive Data
3	TXD	Transmit Data
4	DTR	Data Terminal Ready
5	GND	Signal ground
6	NC	Not connected
7	RTS	Request To Send
8	CTS	Clear To Send
9	NC	Not Connected

4.2.3 AVAILABLE SERIAL SIGNALS

If you are making your own cable, only a few of the cutter's pins will actually need to be connected to the host computer. To ensure optimal results, the cable length should not exceed 4.8 m (16 feet). It should be taken into account that your computer or cutting software may also require additional loopback connections at the host computer's end of the data cable.

- Connect the computer's Transmit Data (TXD) pin to pin # 2 on the cutter.
- Connect the computer's Receive Data (RXD) pin to pin # 3 on the cutter.
- For hardware handshaking, connect the computer's Clear To Send (CTS) pin to pin # 4 or pin # 7 on the cutter. Connect the computer's Request To Send (RTS) pin to pin # 8 on the cutter.
- Connect the computer's ground (GND) pin to pin # 5 on the cutter.

4.3 USB INTERFACE NOTES

4.3.1 USB SPECIFICATIONS

The cutter's built-in USB interface is based on the standards specified in Universal Serial Bus Specifications Revision 1.1.

The cable length should be 5 meters or less.

The adaptable connector type is USB Series "B".

The cable specifications are USB Series A 4-pin for the computer side and USB Series B 4-pin for the cutter side.

4.3.2 INSTALLING THE USB SOFTWARE UNDER WINDOWS

1. Verify that your software will support a USB driver.
The computer should be using either the WIN98 or WIN2000 operating system.
2. Plug the cable connector securely into the cutter's USB interface connector. Plug the other end of the cable into the computer's USB interface connector.
3. The computer should find the new USB device and ask for the driver. Insert the "Gerber Cutter CD: Manuals and Drivers" CD ROM in your CD ROM drive and follow the instructions on the screen.
4. The device driver will be installed.
5. Restart the computer. Next to the cutter's USB connector is a small light emitting diode (LED) that will either be on, blinking or off. If the LED is off then the cutter and the computer are not communicating and all connections must be re-examined.

4.3.3 INSTALLING THE USB SOFTWARE FOR YOUR MACINTOSH

Minimum requirements:

- Macintosh OS 8.5 or higher
- Macintosh with USB connection

Plug the cable connector securely into the cutter's USB interface connector. Plug the other end of the cable into the Mac's USB interface connector.

Insert the "Gerber Cutter CD: Manuals and Drivers" CD-ROM into your Mac's CD-ROM drive. Double-click the "USB Install Driver" icon. This will automatically install the driver and the Gerber PortMapper utility. Restart the computer once installation is complete.

Next to the cutter's USB connector is a small light emitting diode (LED) that will either be on, blinking or off. If the LED is off then the cutter and the computer are not communicating and all connections must be re-examined.

If your software only supports modem or printer port connectivity (e.g. MacCut), use the USB Gerber PortMapper utility to create an emulation of the printer or modem port. Select "USB GerberCutter Port" from within the list of available serial ports. Then select "Create Modem" or "Create Printer Port". Close the USB Gerber PortRemapper and save the settings.

4.3.4 PARALLEL INTERFACE CONNECTOR ON CUTTER

The use of a shielded parallel cable is required.

Parallel Interface Connector			
1	-Data Strobe	19	Ground
2	Data 1	20	Ground
3	Data 2	21	Ground
4	Data 3	22	Ground
5	Data 4	23	Ground
Pin n°	Definition	Pin n°	Definition
6	Data 5	24	Ground
7	Data 6	25	Ground
8	Data 7	26	Ground
9	Data 8	27	Ground
10	-Acknowledge	28	Ground
11	Busy	29	Ground
12	Paper End	30	Ground
13	Select	31	-Input Prime
14	Not Connected	32	-Fault
15	Not Connected	33	Not Connected
16	Logical Ground	34	Not Connected
17	Chassis Ground	35	Not Connected
18	Positive 5V	36	Not Connected
<i>-Negative true logic</i>			

APPENDIX A

5 MEDIA CERTIFICATION

Types of media

A wide range of vinyl types has been evaluated and extensively tested on the Gerber P2C 1600 cutters. Only duly certified media should be used to ensure operation in compliance with the functional specifications of the Gerber P2C cutters as listed in Section 1 of the User's Manual.

Please consult your local Gerber representative for a list of certified media.

GERBER SCIENTIFIC PRODUCTS CONTACT INFORMATION

Gerber Scientific Products
83 Gerber Road
South Windsor, CT 06074 USA
860-643-1515

Customer Service: 800-222-7446
Technical Support: 800-828-5406 / 860-644-6971
Fax 800-227-6228 / 860-871-3862

www.gspinc.com